



**E.I. Williams**

**STEEL DIVISION**

**BUILDING SOUND SOLUTIONS**

reference  
catalogue

**1**

# ROTARY POSITIVE BLOWER INTAKE AND DISCHARGE SILENCERS

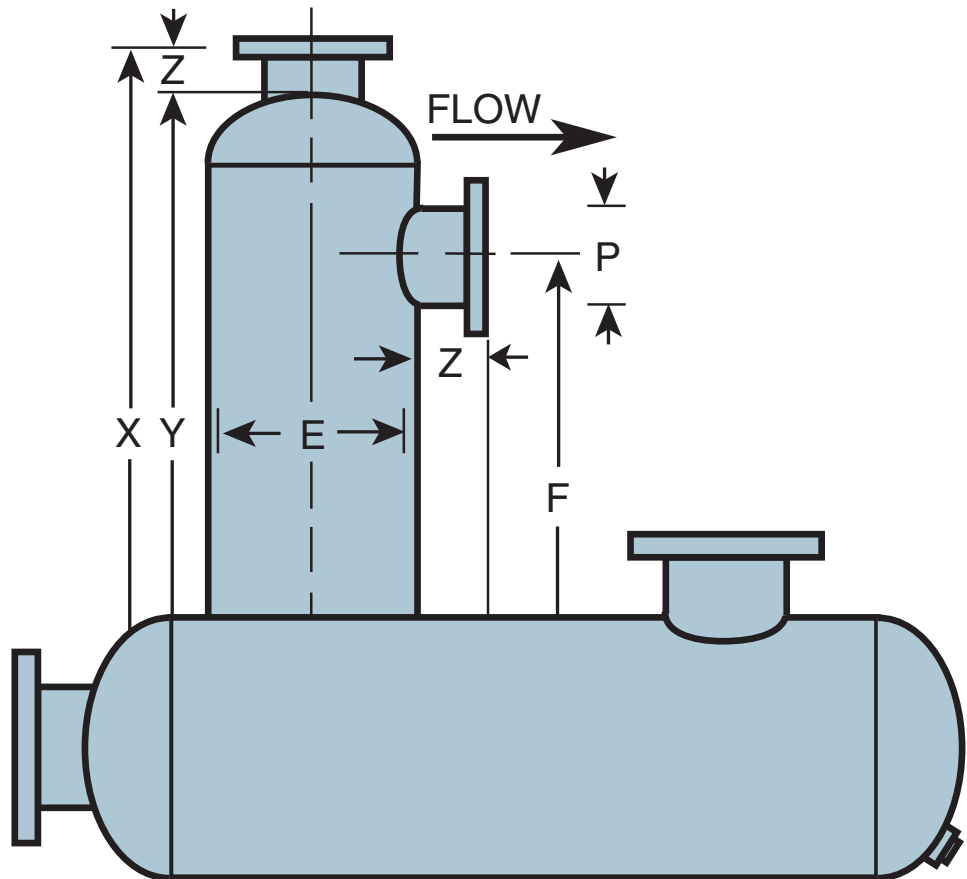

# INFORMATION ON BLOWER SILENCERS

The rotary positive or positive displacement blower is a twin lobe rotating mechanism for delivering large quantity of air or gas at relatively constant volume for either pressure or vacuum applications.

The blower installation produce excessive noise and destructive pulsations which can be harmful for the equipment, personnel and the neighborhood.

In order to achieve silencing and pulsation control, the silencers at intake and discharge are used irrespective of the blower size and speed.

This catalogue deals with different types of intake and discharge silencers for treating airborne noise which can be used depending on the degree of silencing required.

The blower capacities are generally expressed in CFM and the blower size is expressed as gear diameter by rotor length. The pitch line velocity (PLV) or the transition speed is the circumferential velocity of the timing gear i.e. the product of gear circumference and the rotary speed of the blower and generally expressed in feet per minute (FPM).

The noise and pulsation energy generated by blower both at intake and discharge are a function of blower size and blower speed therefore these are important factors to be considered for selecting the correct silencer for intake and discharge.

For the purpose of selection of silencers for blowers, the following considerations must be kept in mind.

1. The silencer must be correctly sized i.e. It should have sufficient volume for the air flow and
2. The silencer must be of proper design.

Normally, there are two basic types of silencers used in the industry. The one is **reactive type** silencer which creates series of cross-sectional discontinuities which results in reflection of sound waves back to the source. The design consists of a series of expansion chambers connected with interconnecting tubes. This type is generally used to treat the low frequency pulsations. The other type is more sophisticated **combination chamber absorption type** design in which acoustical pack sections are added to reactive design to treat the high frequency pulsations. The acoustic energy propagating through the silencer is converted into heat energy in combination silencers for noise reduction.

The pitch line velocity is important criterion for selecting the silencer type. Generally, larger gear diameter and higher rotary speed will produce higher pitch line velocity which results in a greater noise level generated by the blower. It has been recognized by silencing industry that the critical

PLV or transition speed for the blower is 2700 FPM for the discharge and 3300 FPM for intake.

## INTAKE SILENCERS

For intake applications, the PLV or transition speed of 3300 FPM or higher is considered critical. Blowers operating below this speed will need only chamber silencer to adequately silence as the low frequency pulsations are to be treated. If the blower speed is higher than 3300 FPM then high frequency is required to be treated therefore a combination chamber absorption type silencer should be selected.

## DISCHARGE SILENCERS

For discharge applications, the PLV or transition speed of 2700 FPM is accepted as critical speed. Blowers operating below 2700 FPM can be adequately silenced using a chamber type silencer for treating low frequency noise. The blowers operating above 2700 FPM requires a combination chamber absorption type silencer for treating high frequency noise.

## SILENCER SELECTION

Table 1 shows the nominal capacities of various silencers. The size refers to the intake size of the silencers in inches. The capacities are expressed in intake CFM. Select the silencer size corresponding to the volume and discharge pressure of the blower.

**Table 1. Silencer Capacity**

SIZE	INTAKE SILENCER	CAPACITY (Intake CFM @ 14.7 PSIA & 70°F)					
		DISCHARGE SILENCER					
		4 PSIG	6 PSIG	8 PSIG	10 PSIG	12 PSIG	15 PSIG
1	30	35	37	39	41	44	46
1 1/2	68	80	85	89	93	99	104
2	120	140	149	157	164	175	184
2 1/2	188	220	234	246	258	274	288
3	270	317	336	354	370	394	413
3 1/2	368	431	458	482	504	537	563
4	480	563	597	629	658	700	734
5	750	879	933	982	1028	1094	1147
6	1080	1266	1343	1414	1480	1575	1652
8	1920	2251	2388	2514	2630	2800	2937
10	3000	3518	3732	3928	4110	4376	4589
12	4320	5065	5374	5657	5918	6301	6608
14	5880	6895	7314	7700	8056	8576	8994
16	7680	9005	9553	10057	10522	11202	11748
18	9720	11397	12090	12728	13316	14177	14869
20	12000	14070	14927	15714	16440	17502	18356
22	14520	17025	18061	19014	19892	21178	22211
24	17280	20262	21495	22628	23674	25204	26433
26	20280	23779	25226	26556	27784	29580	31022
28	23520	27578	29257	30800	32222	34305	35978
30	27000	31659	33585	35356	36990	39381	41302
EST. TEMP	70°F	115°F	140°F	165°F	190°F	200°F	240°F

For selecting the type of silencer, refer to Table 2, which shows the critical intake and discharge transition speeds (PLV) based on blower gear size. As mentioned earlier, the critical PLV for intake silencers is 3300 FPM and for discharge silencers is 2700 FPM. For intake silencers, if your blower's operating speed is above the intake value then select the combination chamber absorption silencer and if it is below the intake value then select chamber silencer.

**Table 2. Blower Transition Speed**

BLOWER GEAR SIZE INCHES	TRANSITION SPEED - R.P.M.	
	INTAKE	DISCHARGE
2	6300	5155
2 1/2	5040	4125
3	4200	3435
4	3150	2575
5	2520	2060
6	2100	1720
7	1800	1470
8	1575	1290
10	1260	1030
12	1050	860
14	900	735
16	785	645
18	700	570
20	630	515
22	570	470
24	525	430

Similarly, for discharge silencers, if your blower's operating speed is above the discharge value then select combination chamber absorption silencer and if it is below the discharge value then select the chamber silencer.

Refer Table 3 for silencer model depending on whether standard silencing or maximum silencing is required.

**Table 3. Silencer Model Recommendations**

PITCH LINE VELOCITY	INTAKE		DISCHARGE	
	Standard Silencing	Maximum Silencing	Standard Silencing	Maximum Silencing
Below Transition	IS12, IS12S IS12TS	S14, S14S S14TS, S14SS	S12, S12S S12TS	S14, S14S S14TS, S14SS
Above Transition	IS42, IS42S	IS43, IS43S IS 43TS	S42, S42S S42TS, S42SS	S44, S44S S44TS, S44SS

### ATTENUATION CURVES

Noise attenuation curves showing insertion loss at each frequency are shown for various models. These curves represent the insertion loss for airborne noise under average conditions. The resultant silenced noise level will depend on number of other factors therefore these curves should be used with discretion and can be used as a guideline for evaluating the noise levels of a blower after the silencer installation.

### INSTALLATION

As a general rule, the silencer must be installed as close as possible to the blower to avoid radiated noise from silencer using a flexible coupling to eliminate stresses and fatigue which can cause premature failure of silencer or piping. Consult our engineers for any specific silencer orientation required.

### PRESSURE RATING

The silencers described herein are designed to a maximum operating pressure of 15 psig. For applications where pressure exceeds 15 psig, the silencers can be designed to ASME Code, Section 8, Div. 1 for pressure vessel construction. The dimensions are similar to standard models, but the material types and thicknesses are selected to meet code requirements. Consult our engineers for pricing and design information.

### PRESSURE DROP

The following formulas may be used to calculate pressure drop through the silencers covered in this catalogue.

$$\text{INTAKE: } \Delta P = \left( \frac{V}{4005} \right)^2 C \quad (\text{assumes silencer intake is open to atmosphere})$$

$$\text{DISCHARGE: } \Delta P = \left( \frac{V}{4005} \right)^2 C \times \frac{P}{14.7} \times \frac{530}{T}$$

- Δ P = Pressure drop through silencer, inches H<sub>2</sub>O.
- V = Air velocity through silencer, feet per minute (')
- C = Individual Silencer restriction coefficient - empirical constant (See Table 4)
- P = Discharge pressure, PSIA (operating pressure in PSIG + 14.7)
- T = Discharge temperature, °R. absolute (operating temperature in °F. + 460)

(1) to calculate velocity through silencer, divide flow in ACFM by cross sectional area of silencer intake diameter in square feet.

**Table 4. Pressure Drop Coefficients (c)**

SILENCER MODEL	PRESSURE DROP COEFFICIENT - C
S14, S14S, S14TS	4.2
S12, S12S, S12TS	4.2
IS12, IS12S, IS12TS	4.2
IS42, IS42S	4.2
IS43, IS43S, IS43TS	4.2
S42, S42S, S42TS	4.2
S44, S44S, S44TS	4.2
S14SS, S42SS, S44SS	7.0

Contact our engineers for assistance in your Blower Silencer selection and sizing problems.

### TEMPERATURE LIMITS

The chamber absorption silencers described in this catalogue use polyester wool packing as the standard acoustical absorption material. The temperature limit for polyester wool is 492°F. For applications where the temperature exceeds this range, consult our engineers for alternate materials.

# SPECIFICATIONS

## S12 Series Chamber Construction Discharge Silencers

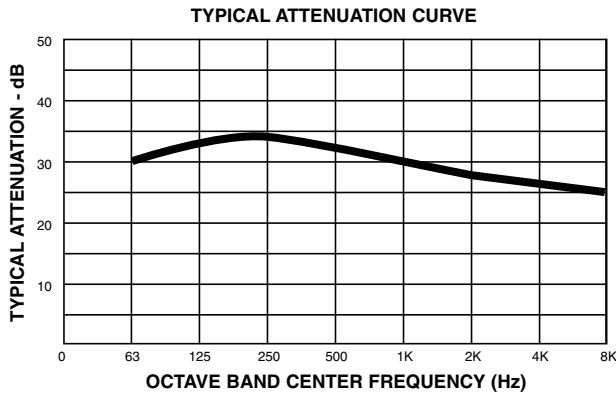

The S12 Series Discharge silencers are recommended for achieving **standard silencing** for blowers operating **below transition speed**. The design consists of a multi-chamber, multi-tube arrangement which properly eliminates destructive pulsations. The standard construction is heavy duty all welded carbon steel sheet and plates. The units 6" and above are provided with flanged connections drilled to 125 lbs. ANSI specifications. The external surfaces are rust inhibitive primer coated. Custom designs available to suit specific nozzle orientations. The optional features include inspection openings, mounting brackets, couplings for relief valve installations, special material, special paint or ASME code construction.

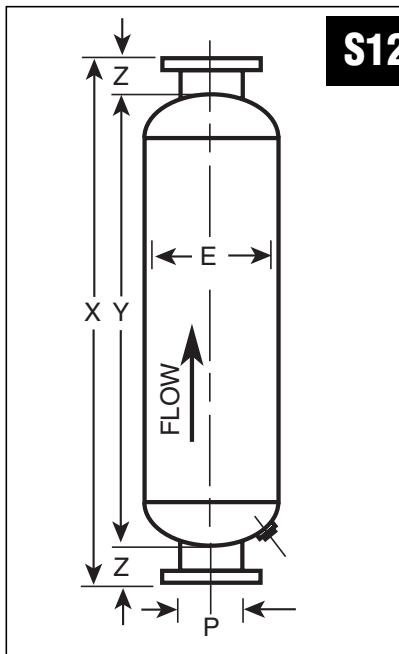

MODEL	PIPE SIZE P	E	X	Y	Z	WT.
S12 - 1	1	4 1/2	22	18	2	10
S12 - 1 1/2	1 1/2	6 1/2	25	21	2	15
S12 - 2	2	8	33	27	3	25
S12 - 2 1/2	2 1/2	10	34	28	3	35
S12 - 3	3	10	51	45	3	45
S12 - 3 1/2	3 1/2	12	52	46	3	60
S12 - 4	4	14	53	47	3	80
S12 - 5	5	16	65	59	3	130
S12 - 6	6	18	72	66	3	170
S12 - 8	8	22	68	60	4	320
S12 - 10	10	26	81	73	4	385
S12 - 12	12	30	88	80	4	640
S12 - 14	14	30	100	92	4	725
S12 - 16	16	36	120	112	4	1050
S12 - 18	18	42	127	119	4	1350
S12 - 20	20	42	140	130	5	1450
S12 - 22	22	48	158	148	5	2200
S12 - 24	24	54	167	157	5	2650

### Std. fittings

- up to 3 1/2" size - Male thread nipples
- 4" & 5" sizes - optional - male thread nipples or flanges
- 6" & above - 125 lbs. ANSI flange drilling

- Dimensions and weights are approximate and may change slightly with production models.
- Dimension in inches.
- Weight in lbs.

**We specialize in custom designs and also provide various nozzle orientations to suit your specific requirements.**

MODEL	PIPE SIZE P	E	X	Y	Z	G	F		WT.
							MIN.	MAX.	
S12S - 2	2	8	30	27	3	7	6	9	25
S12S - 2 1/2	2 1/2	10	31	28	3	8	6	10	35
S12S - 3	3	10	48	45	3	8	6	20	45
S12S - 4	4	14	50	47	3	10	7	23	80
S12S - 5	5	16	62	59	3	11	8	27	130
S12S - 6	6	18	69	66	3	12	9	33	170
S12S - 8	8	22	64	60	4	15	10	22	320
S12S - 10	10	26	77	73	4	17	12	30	385
S12S - 12	12	30	84	80	4	19	13	34	640
S12S - 14	14	30	96	92	4	19	14	40	725
S12S - 16	16	36	116	112	4	22	15	45	1050
S12S - 18	18	42	123	119	4	25	18	50	1350
S12S - 20	20	42	135	130	5	26	19	55	1450
S12S - 22	22	48	153	148	5	29	21	65	2200
S12S - 24	24	54	162	157	5	32	22	67	2650

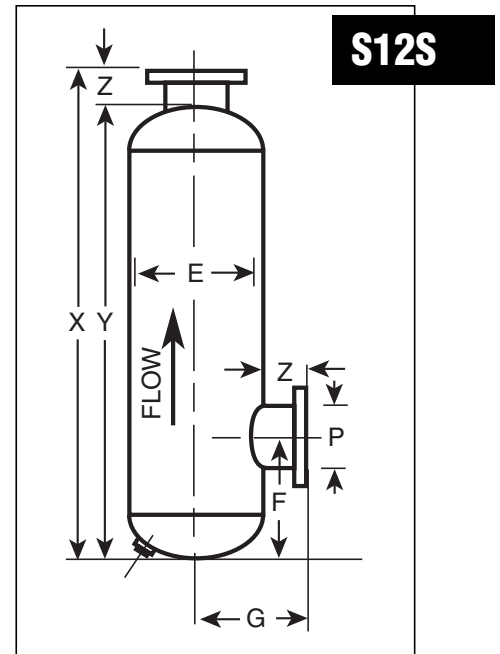

MODEL	PIPE SIZE P	E	X	Y	Z	G	F		WT.
							MIN.	MAX.	
S12TS - 8	8	22	64	60	4	15	32	46	320
S12TS - 10	10	26	77	73	4	17	40	58	385
S12TS - 12	12	30	84	80	4	19	46	68	640
S12TS - 14	14	30	96	92	4	19	48	79	725
S12TS - 16	16	36	116	112	4	22	61	91	1050
S12TS - 18	18	42	123	119	4	25	69	102	1350
S12TS - 20	20	42	135	130	5	26	76	114	1450
S12TS - 22	22	48	153	148	5	29	88	126	2200
S12TS - 24	24	54	162	157	5	32	90	135	2650

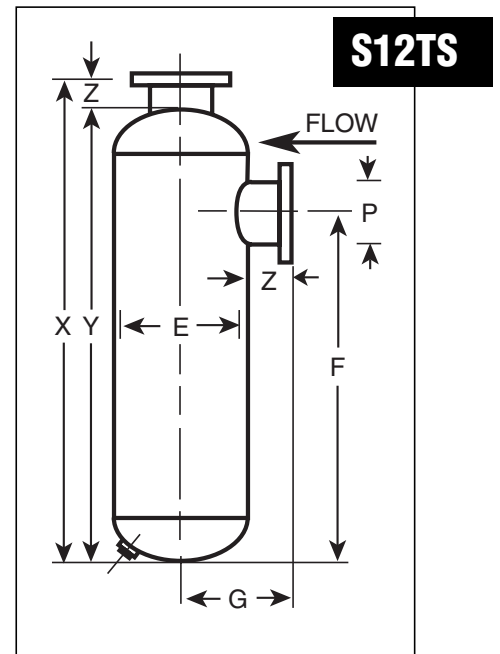

# SPECIFICATIONS

## S14 Series Chamber Construction Discharge Silencers

TYPICAL ATTENUATION CURVE

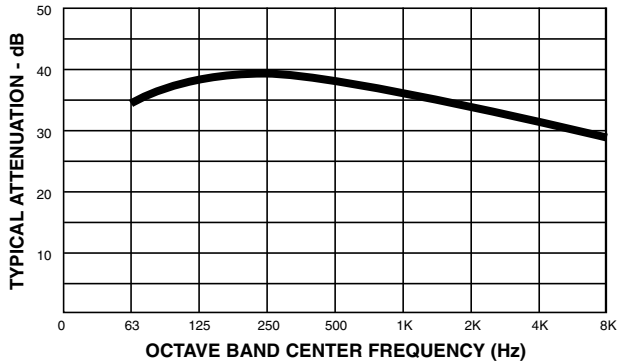

The S14 Series Discharge Silencers are recommended for achieving **maximum silencing** for blowers operating **below transition speed**. The design consists of a multi-chamber, multi-tube arrangement which properly eliminates destructive pulsations. The standard construction is heavy duty all welded carbon steel sheet and plates. The units 6" and above are provided with flanged connections drilled to 125 lbs. ANSI specifications. The external surfaces are rust inhibitive primer coated. Custom designs available to suit specific nozzle orientations. The optional features include inspection openings, mounting brackets, couplings for relief valve installations, special material, special paint, or ASME Code Construction.

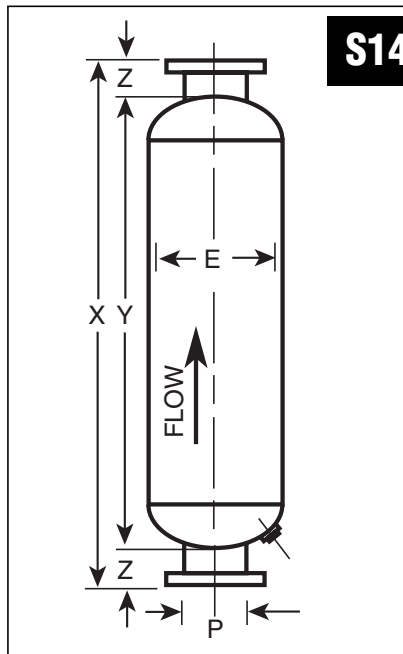

**S14**

MODEL	PIPE SIZE P	E	X	Y	Z	WT.
S14 - 1	1	4 1/2	22	18	2	10
S14 - 1 1/2	1 1/2	6 1/2	25	21	2	15
S14 - 2	2	8	33	27	3	25
S14 - 2 1/2	2 1/2	10	34	28	3	35
S14 - 3	3	10	51	45	3	45
S14 - 3 1/2	3 1/2	12	52	46	3	60
S14 - 4	4	14	53	47	3	80
S14 - 5	5	16	65	59	3	130
S14 - 6	6	18	72	66	3	170
S14 - 8	8	22	97	89	4	360
S14 - 10	10	26	122	114	4	600
S14 - 12	12	30	134	126	4	900
S14 - 14	14	36	162	154	4	1400
S14 - 16	16	42	180	172	4	1900
S14 - 18	18	48	188	180	4	2600
S14 - 20	20	48	202	192	5	2900
S14 - 22	22	54	205	195	5	3600
S14 - 24	24	54	240	230	5	4400

**Std. fittings**

- up to 3 1/2" size - Male thread nipples
- 4" & 5" sizes - optional - male thread nipples or flanges
- 6" & above - 125 lbs. ANSI flange drilling

- Dimensions and weights are approximate and may change slightly with production models.
- Dimension in inches.
- Weight in lbs.

**We specialize in custom designs and also provide various nozzle orientations to suit your specific requirements.**

MODEL	PIPE SIZE P	E	X	Y	Z	G	F		WT.
							MIN.	MAX.	
S14S - 2	2	8	30	27	3	7	6	9	25
S14S - 2 1/2	2 1/2	10	31	28	3	8	6	10	35
S14S - 3	3	10	48	45	3	8	6	20	45
S14S - 4	4	14	50	47	3	10	7	23	80
S14S - 5	5	16	62	59	3	11	8	27	130
S14S - 6	6	18	69	66	3	12	9	33	170
S14S - 8	8	22	93	89	4	15	10	42	360
S14S - 10	10	26	118	114	4	17	13	56	600
S14S - 12	12	30	130	126	4	19	14	68	900
S14S - 14	14	36	158	154	4	22	16	70	1400
S14S - 16	16	42	176	172	4	25	18	82	1900
S14S - 18	18	48	184	180	4	28	20	89	2600
S14S - 20	20	48	197	192	5	29	22	95	2900
S14S - 22	22	54	200	195	5	32	25	98	3600
S14S - 24	24	54	235	230	5	32	26	102	4400

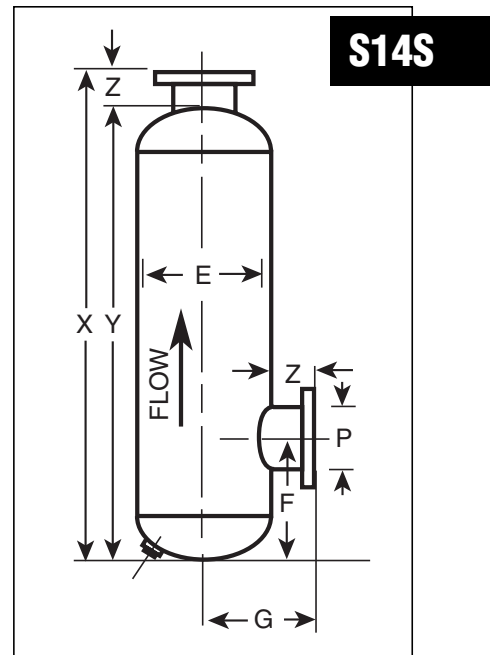

MODEL	PIPE SIZE P	E	X	Y	Z	G	F		WT.
							MIN.	MAX.	
S14TS - 8	8	22	93	89	4	15	60	80	360
S14TS - 10	10	26	118	114	4	17	74	104	600
S14TS - 12	12	30	130	126	4	19	85	115	900
S14TS - 14	14	36	158	154	4	22	104	138	1400
S14TS - 16	16	42	176	172	4	25	115	155	1900
S14TS - 18	18	48	184	180	4	28	123	162	2600
S14TS - 20	20	48	197	192	5	29	130	172	2900
S14TS - 22	22	54	200	195	5	32	133	173	3600
S14TS - 24	24	54	235	230	5	32	152	205	4400

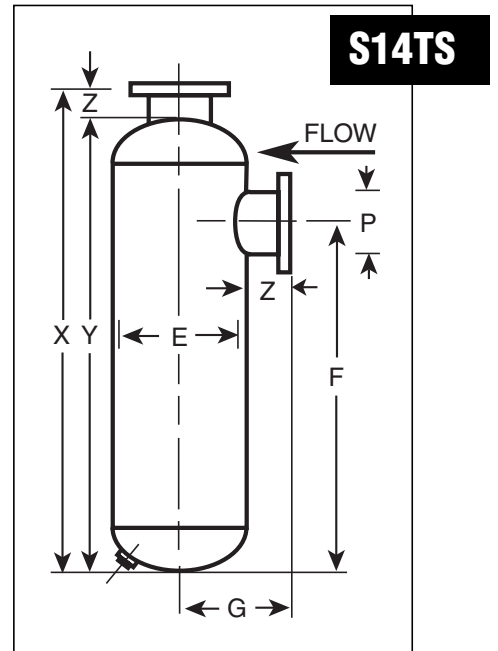

MODEL	PIPE SIZE P	E	X	Z	G	F		WT.
						MIN.	MAX.	
S14SS - 4	4	14	47	3	10	8	15	80
S14SS - 5	5	16	59	3	11	10	18	130
S14SS - 6	6	18	66	3	12	11	21	170
S14SS - 8	8	22	89	4	15	13	28	360
S14SS - 10	10	26	114	4	17	16	39	600
S14SS - 12	12	30	126	4	19	17	40	900
S14SS - 14	14	36	154	4	22	19	47	1400
S14SS - 16	16	42	172	4	25	21	53	1900
S14SS - 18	18	48	180	4	28	23	54	2600
S14SS - 20	20	48	192	5	29	25	58	2900
S14SS - 22	22	54	195	5	32	28	61	3600
S14SS - 24	24	54	230	5	32	29	68	4400

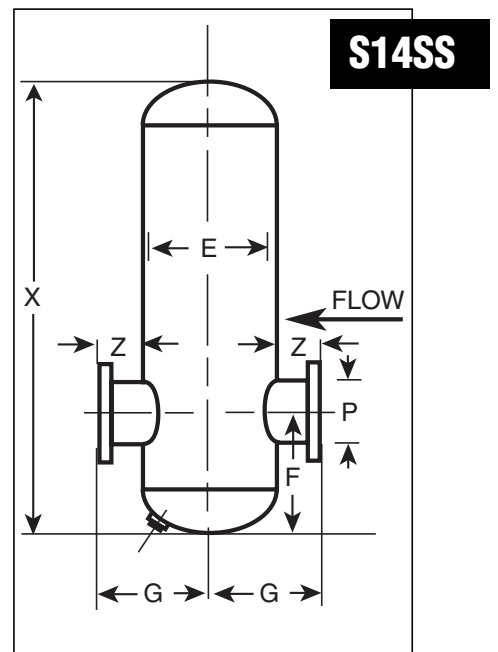

# SPECIFICATIONS

## S42 Series Combination Chamber Absorption Type Discharge Silencers

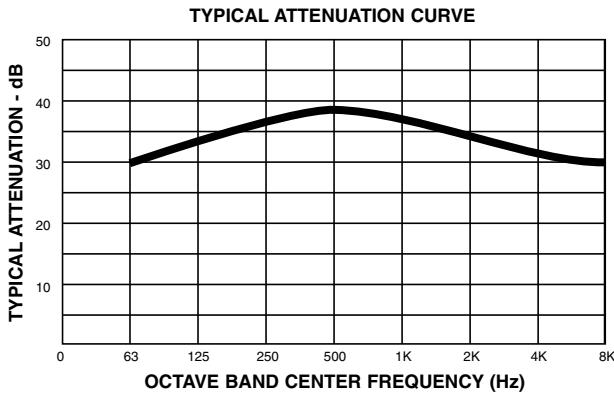

The S42 Series Discharge silencers are recommended for achieving **standard silencing** for blowers operating **above transition speed** where noise level criteria are not stringent. The design consists of a multi-chamber, multi-tube arrangement incorporating high frequency absorption packing material which effectively treats the destructive pulsations and excessive high frequency noise by converting noise energy into heat. The standard construction is heavy duty all welded carbon steel sheet and plates. The units 6" and above are provided with flanged connections drilled to 125 lbs. ANSI specifications. The external surfaces are rust inhibitive primer coated. Custom designs available to suit specific nozzle orientations. The optional features include inspection openings, mounting brackets, couplings for relief valve installations, special material, special paint or ASME code construction.

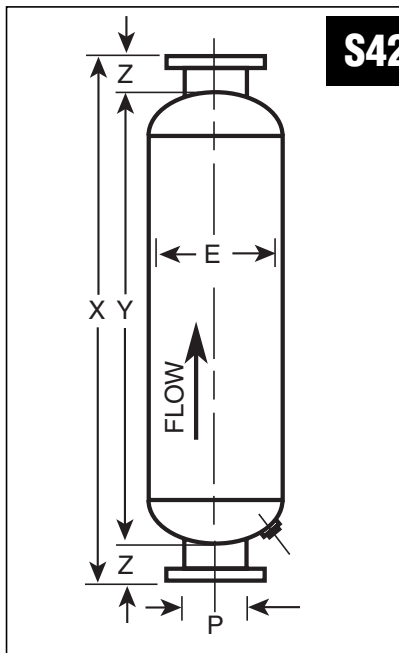

MODEL	PIPE SIZE P	E	X	Y	Z	WT.
S42 - 2	2	8	33	27	3	30
S42 - 2 1/2	2 1/2	10	34	28	3	45
S42 - 3	3	10	51	45	3	60
S42 - 3 1/2	3 1/2	12	52	46	3	80
S42 - 4	4	14	53	47	3	105
S42 - 5	5	16	65	59	3	165
S42 - 6	6	18	72	66	3	205
S42 - 8	8	18	79	71	4	250
S42 - 10	10	22	92	84	4	400
S42 - 12	12	26	111	103	4	600
S42 - 14	14	30	124	116	4	950
S42 - 16	16	36	138	130	4	1400
S42 - 18	18	42	151	143	4	1800
S42 - 20	20	42	176	166	5	2200
S42 - 22	22	48	195	185	5	2900
S42 - 24	24	54	214	204	5	3600

### Std. fittings

- up to 3 1/2" size - Male thread nipples
- 4" & 5" sizes - optional - male thread nipples or flanges
- 6" & above - 125 lbs. ANSI flange drilling

- Dimensions and weights are approximate and may change slightly with production models.
- Dimension in inches.
- Weight in lbs.

**We specialize in custom designs and also provide various nozzle orientations to suit your specific requirements.**



MODEL	PIPE SIZE P	E	X	Y	Z	G	F		WT.
							MIN.	MAX.	
S42S - 2	2	8	30	27	3	9	6	9	30
S42S - 2 1/2	2 1/2	10	31	28	3	10	7	10	45
S42S - 3	3	10	48	45	3	11	7	16	60
S42S - 4	4	14	50	47	3	14	8	18	105
S42S - 5	5	16	62	59	3	15	9	21	165
S42S - 6	6	18	69	66	3	17	10	24	205
S42S - 8	8	18	75	71	4	22	12	18	250
S42S - 10	10	22	88	84	4	28	14	23	400
S42S - 12	12	26	107	103	4	32	16	32	600
S42S - 14	14	30	120	116	4	36	17	36	950
S42S - 16	16	36	134	130	4	42	19	37	1400
S42S - 18	18	42	147	143	4	46	21	39	1800
S42S - 20	20	42	171	166	5	50	22	46	2200
S42S - 22	22	48	190	185	5	58	24	54	2900
S42S - 24	24	54	209	204	5	61	26	65	3600

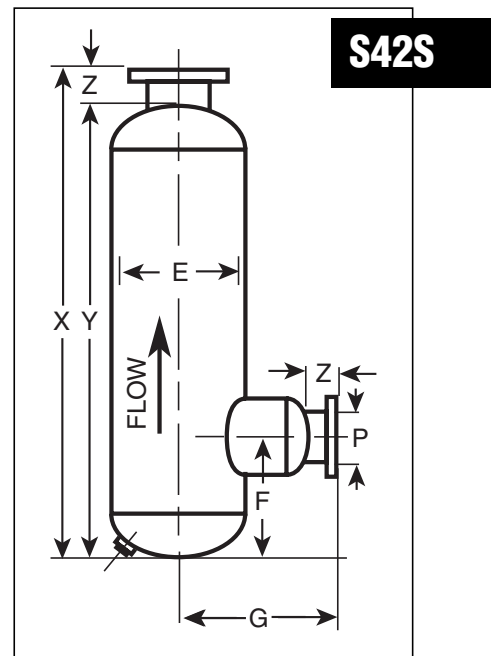

MODEL	PIPE SIZE P	E	X	Y	Z	G	K	F		WT.
								MIN.	MAX.	
S42TS - 4	4	14	50	47	3	16	3 1/2	31	38	105
S42TS - 5	5	16	62	59	3	18	4	41	50	165
S42TS - 6	6	18	69	66	3	22	4 1/2	42	55	205
S42TS - 8	8	18	75	71	4	25	4 1/2	44	58	250
S42TS - 10	10	22	88	84	4	29	5 1/2	56	68	400
S42TS - 12	12	26	107	103	4	35	6	73	86	600
S42TS - 14	14	30	120	116	4	40	6	82	98	950
S42TS - 16	16	36	134	130	4	43	9	92	110	1400
S42TS - 18	18	42	147	143	4	50	10	100	120	1800
S42TS - 20	20	42	171	166	5	56	9	110	136	2200
S42TS - 22	22	48	190	185	5	62	11	125	155	2900
S42TS-24	24	54	209	204	5	69	13	140	172	3600

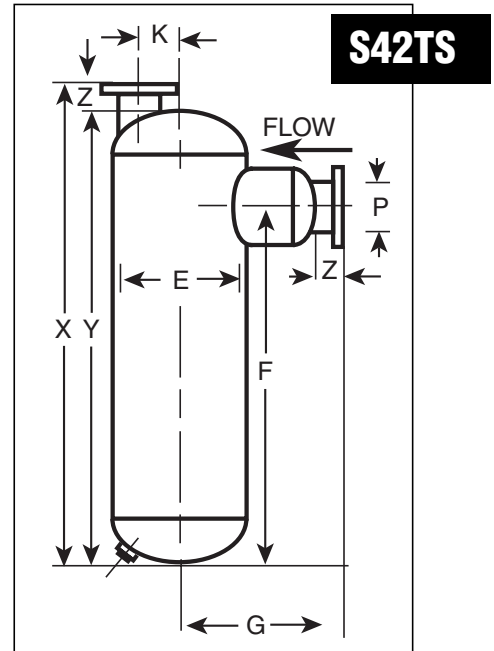

MODEL	PIPE SIZE P	E	X	Z	G	C	F		WT.
							MIN.	MAX.	
S42SS - 4	4	14	47	3	15	10	8	14	105
S42SS - 5	5	16	59	3	17	11	9	16	165
S42SS - 6	6	18	66	3	21	12	10	20	205
S42SS - 8	8	18	71	4	27	13	12	18	250
S42SS - 10	10	22	84	4	33	15	14	23	400
S42SS - 12	12	26	103	4	38	17	16	32	600
S42SS - 14	14	30	116	4	40	19	17	36	950
S42SS - 16	16	36	130	4	47	22	19	37	1400
S42SS - 18	18	42	143	4	52	25	21	39	1800
S42SS - 20	20	42	166	5	62	26	22	46	2200
S42SS - 22	22	48	185	5	65	29	24	54	2900
S42SS - 24	24	54	204	5	69	32	26	65	3600

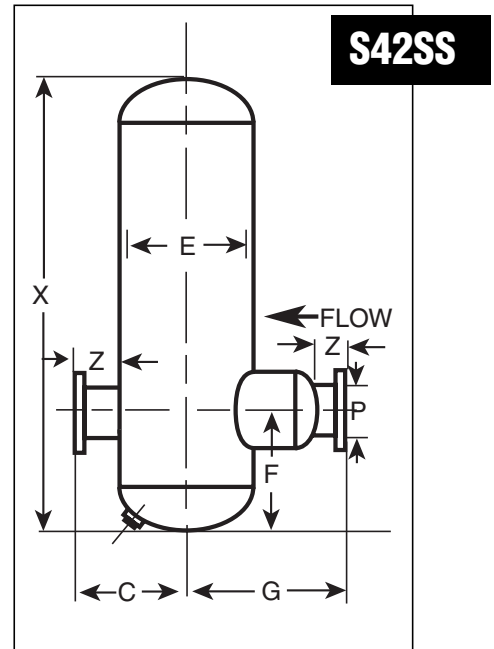

# SPECIFICATIONS

## S44 Series Combination Chamber Absorption Type Discharge Silencers

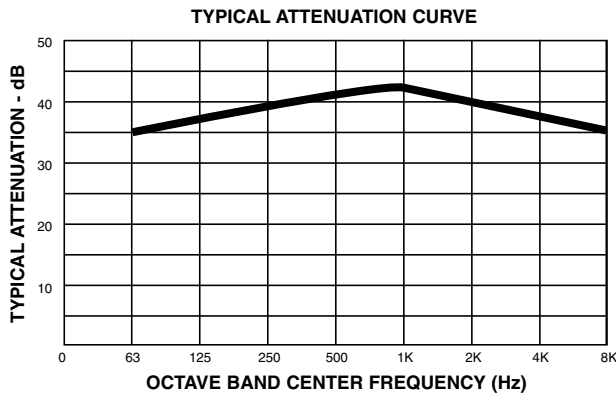

The S44 Series Discharge silencers are recommended for achieving **maximum silencing** for blowers operating **above transition speed** where noise level criteria are stringent. The design consists of a multi chamber, multi-tube arrangement incorporating high frequency absorption packing material which effectively treats the destructive pulsations and excessive high frequency noise by converting noise energy into heat. The standard construction is heavy duty all welded carbon steel sheet and plates. The units 6" and above are provided with flanged connections drilled to 125 lbs. ANSI specifications. The external surfaces are rust inhibitive primer coated. Custom designs available to suit specific nozzle orientations. The optional features include inspection openings, mounting brackets, couplings for relief valve installations, special material, special paint or ASME code construction.

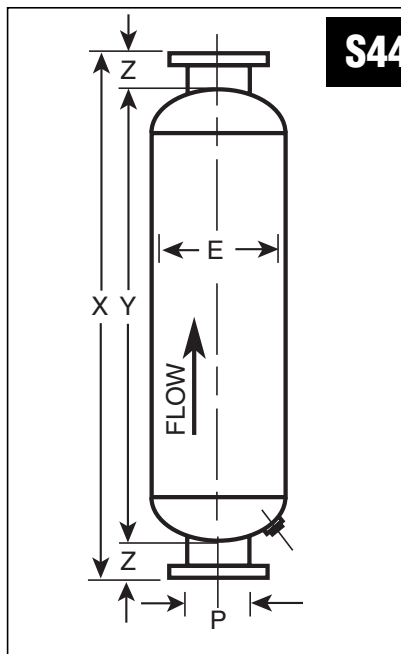

MODEL	PIPE SIZE P	E	X	Y	Z	WT.
S44 - 2	2	8	33	27	3	30
S44 - 2 1/2	2 1/2	10	34	28	3	45
S44 - 3	3	10	51	45	3	60
S44 - 3 1/2	3 1/2	12	52	46	3	80
S44 - 4	4	14	53	47	3	105
S44 - 5	5	16	65	59	3	165
S44 - 6	6	18	72	66	3	205
S44 - 8	8	22	97	89	4	420
S44 - 10	10	26	122	114	4	680
S44 - 12	12	30	134	126	4	1040
S44 - 14	14	36	162	154	4	1600
S44 - 16	16	42	180	172	4	2200
S44 - 18	18	48	188	180	4	3100
S44 - 20	20	48	202	192	5	3400
S44 - 22	22	54	205	195	5	4100
S44 - 24	24	54	240	230	5	4900

### Std. fittings

- up to 3 1/2" size - Male thread nipples
- 4" & 5" sizes - optional - male thread nipples or flanges
- 6" & above - 125 lbs. ANSI flange drilling

- Dimensions and weights are approximate and may change slightly with production models.
- Dimension in inches.
- Weight in lbs.

**We specialize in custom designs and also provide various nozzle orientations to suit your specific requirements.**

MODEL	PIPE SIZE P	E	X	Y	Z	G	F		WT.
							MIN.	MAX.	
S44S - 2	2	8	30	27	3	9	6	9	30
S44S - 2 1/2	2 1/2	10	31	28	3	10	7	10	45
S44S - 3	3	10	48	45	3	11	7	16	60
S44S - 4	4	14	50	47	3	14	8	18	105
S44S - 5	5	16	62	59	3	15	9	21	165
S44S - 6	6	18	69	66	3	17	10	24	205
S44S - 8	8	22	93	89	4	24	12	26	420
S44S - 10	10	26	118	114	4	30	15	35	680
S44S - 12	12	30	130	126	4	36	17	39	1040
S44S - 14	14	36	158	154	4	42	18	40	1600
S44S - 16	16	42	176	172	4	46	21	44	2200
S44S - 18	18	48	184	180	4	50	23	46	3100
S44S - 20	20	48	197	192	5	56	24	47	3400
S44S - 22	22	54	200	195	5	64	26	48	4100
S44S - 24	24	54	235	230	5	68	28	54	4900

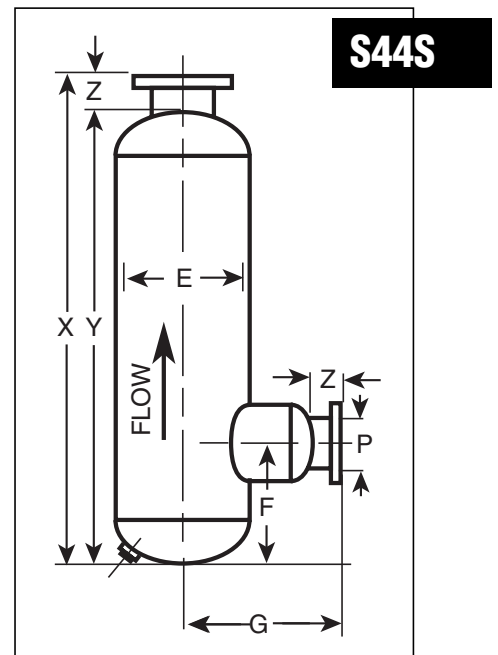

MODEL	PIPE SIZE P	E	X	Y	Z	G	K	F		WT.
								MIN.	MAX.	
S44TS - 4	4	14	50	47	3	16	3 1/2	31	38	105
S44TS - 5	5	16	62	59	3	18	4	41	50	165
S44TS - 6	6	18	69	66	3	22	4 1/2	42	55	205
S44TS - 8	8	22	93	89	4	28	5 1/2	64	77	420
S44TS - 10	10	26	118	114	4	33	6	76	101	680
S44TS - 12	12	30	130	126	4	38	7	87	109	1040
S44TS - 14	14	36	158	154	4	43	9	106	135	1600
S44TS - 16	16	42	176	172	4	48	10	118	152	2200
S44TS - 18	18	48	184	180	4	52	12	125	157	3100
S44TS - 20	20	48	197	192	5	62	11	133	168	3400
S44TS - 22	22	54	200	195	5	69	13	137	168	4100
S44TS - 24	24	54	235	230	5	78	13	155	205	4900

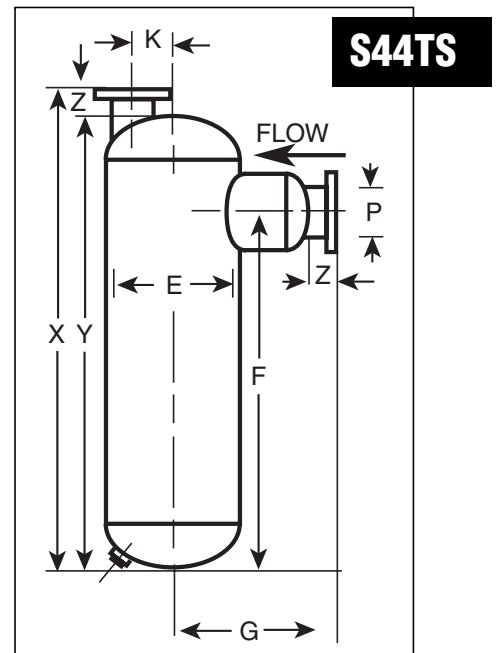

MODEL	PIPE SIZE P	E	X	Z	G	C	F		WT.
							MIN.	MAX.	
S44SS - 4	4	14	47	3	15	10	8	14	105
S44SS - 5	5	16	59	3	17	11	9	16	165
S44SS - 6	6	18	66	3	21	12	10	20	205
S44SS - 8	8	22	89	4	26	15	12	26	420
S44SS - 10	10	26	114	4	32	17	15	35	680
S44SS - 12	12	30	126	4	40	19	17	39	1040
S44SS - 14	14	36	154	4	48	22	18	40	1600
S44SS - 16	16	42	172	4	54	25	21	44	2200
S44SS - 18	18	48	180	4	60	28	23	46	3100
S44SS - 20	20	48	192	5	66	29	24	47	3400
S44SS - 22	22	54	195	5	72	32	26	48	4100
S44SS - 24	24	54	230	5	79	32	28	54	4900

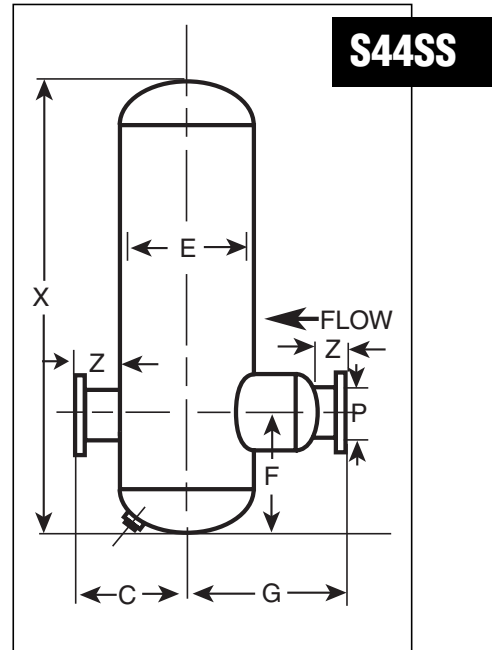

# SPECIFICATIONS

## IS12 Series Chamber Construction Intake Silencers

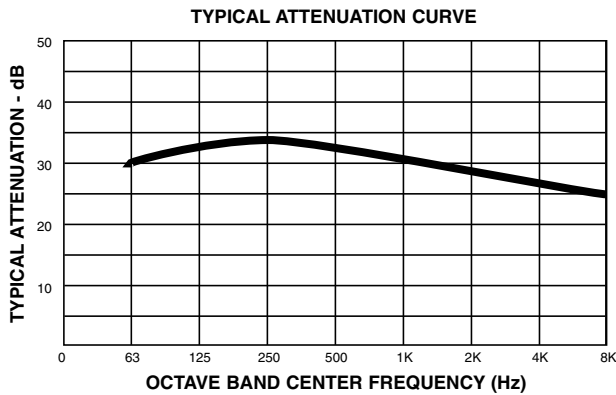

The IS12 Series Intake silencers are recommended for achieving **standard silencing** for blowers operating **below transition speed**. The design consists of a multi-chamber, multi-tube arrangement which properly eliminates destructive pulsations. The standard construction is heavy duty all welded carbon steel sheet and plates. The units 6" and above are provided with flanged connections drilled to 125 lbs. ANSI specifications. The external surfaces are rust inhibitive primer coated. Custom designs available to suit specific nozzle orientations. The optional features include inspection openings, mounting brackets, couplings for relief valve installations, special material, special paint or ASME code construction.

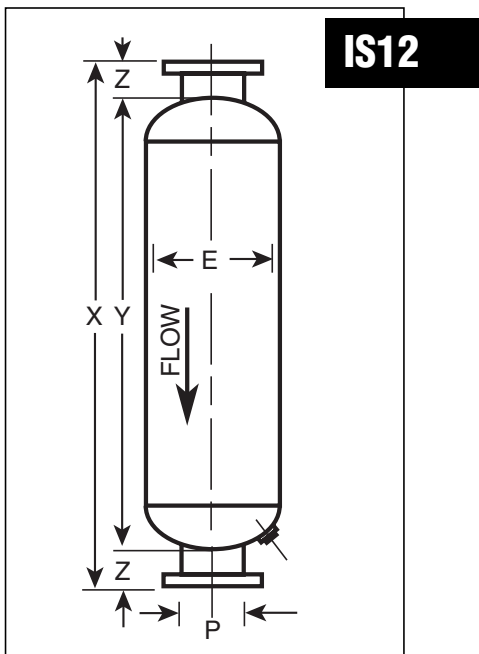

MODEL	PIPE SIZE P	E	X	Y	Z	WT.
IS12 - 1	1	4 1/2	22	18	2	10
IS12 - 1 1/2	1 1/2	6 1/2	25	21	2	15
IS12 - 2	2	8	33	27	3	25
IS12 - 2 1/2	2 1/2	10	34	28	3	35
IS12 - 3	3	10	51	45	3	45
IS12 - 3 1/2	3 1/2	12	52	46	3	60
IS12 - 4	4	14	53	47	3	80
IS12 - 5	5	16	65	59	3	130
IS12 - 6	6	18	72	66	3	170
IS12 - 8	8	22	68	60	4	320
IS12 - 10	10	26	81	73	4	385
IS12 - 12	12	30	88	80	4	640
IS12 - 14	14	30	100	92	4	725
IS12 - 16	16	36	120	112	4	1050
IS12 - 18	18	42	127	119	4	1350
IS12 - 20	20	42	140	130	5	1450
IS12 - 22	22	48	158	148	5	2200
IS12 - 24	24	54	167	157	5	2650

### Std. fittings

- up to 3 1/2" size - Male thread nipples
- 4" & 5" sizes - optional - male thread nipples or flanges
- 6" & above - 125 lbs. ANSI flange drilling

- Dimensions and weights are approximate and may change slightly with production models.
- Dimension in inches.
- Weight in lbs.

**We specialize in custom designs and also provide various nozzle orientations to suit your specific requirements.**

MODEL	PIPE SIZE P	E	X	Y	Z	G	F		WT.
							MIN.	MAX.	
IS12S - 2	2	8	30	27	3	7	6	9	25
IS12S - 2 1/2	2 1/2	10	31	28	3	8	6	10	35
IS12S - 3	3	10	48	45	3	8	6	20	45
IS12S - 4	4	14	50	47	3	10	7	23	80
IS12S - 5	5	16	62	59	3	11	8	27	130
IS12S - 6	6	18	69	66	3	12	9	33	170
IS12S - 8	8	22	64	60	4	15	10	22	320
IS12S - 10	10	26	77	73	4	17	12	30	385
IS12S - 12	12	30	84	80	4	19	13	34	640
IS12S - 14	14	30	96	92	4	19	14	40	725
IS12S - 16	16	36	116	112	4	22	15	45	1050
IS12S - 18	18	42	123	119	4	25	18	50	1350
IS12S - 20	20	42	135	130	5	26	19	55	1450
IS12S - 22	22	48	153	148	5	29	21	65	2200
IS12S - 24	24	54	162	157	5	32	22	67	2650

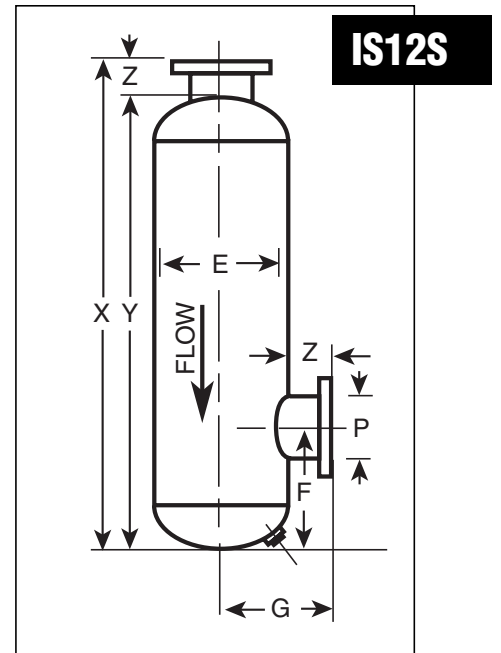

MODEL	PIPE SIZE P	E	X	Y	Z	G	F		WT.
							MIN.	MAX.	
IS12TS - 8	8	22	64	60	4	15	32	46	320
IS12TS - 10	10	26	77	73	4	17	40	58	385
IS12TS - 12	12	30	84	80	4	19	46	68	640
IS12TS - 14	14	30	96	92	4	19	48	79	725
IS12TS - 16	16	36	116	112	4	22	61	91	1050
IS12TS - 18	18	42	123	119	4	25	69	102	1350
IS12TS - 20	20	42	135	130	5	26	76	114	1450
IS12TS - 22	22	48	153	148	5	29	88	126	2200
IS12TS - 24	24	54	162	157	5	32	90	135	2650

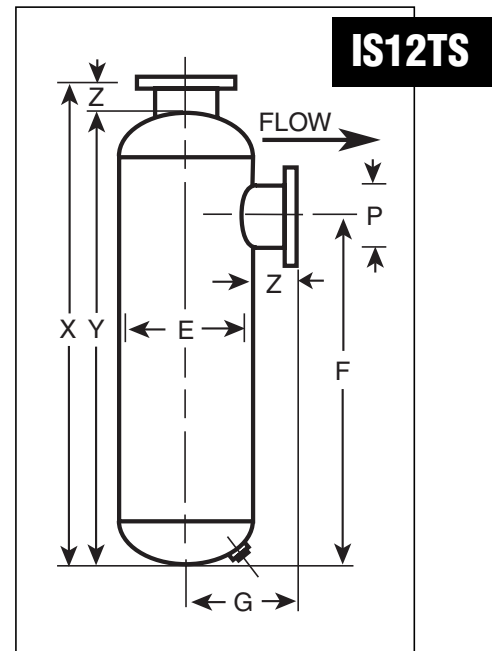

# SPECIFICATIONS

## IS42 Series Combination Chamber Absorption Type Intake Silencers

TYPICAL ATTENUATION CURVE

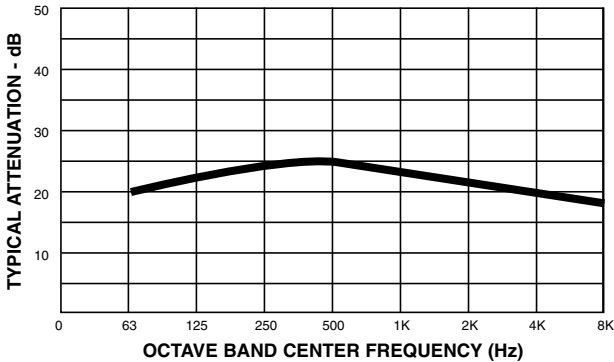

The IS42 Series Intake silencers are recommended for achieving **standard silencing** for blowers operating **above transition speed** where noise level criteria are not stringent. The design consists of a multi-chamber, multi-tube arrangement incorporating high frequency absorption packing material which effectively treats the destructive pulsations and excessive high frequency noise by converting noise energy into heat. The standard construction is heavy duty all welded carbon steel sheet and plates. The units 6" and above are provided with flanged connections drilled to 125 lbs. ANSI specifications. The external surfaces are rust inhibitive primer coated. Custom designs available to suit specific nozzle orientations. The optional features include inspection openings, mounting brackets, couplings for relief valve installations, special material, special paint or ASME code construction.

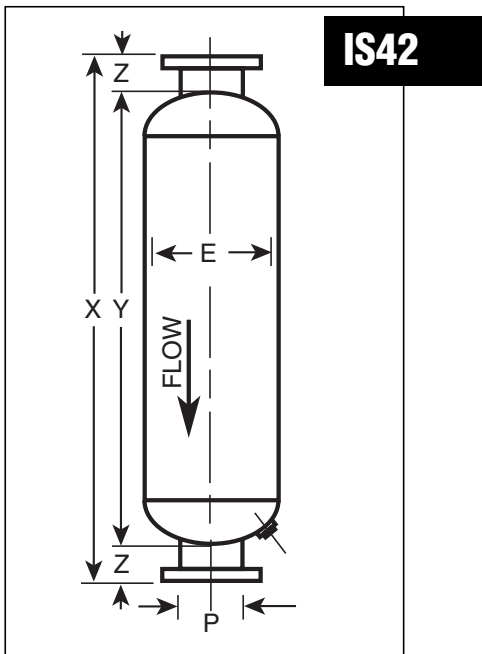

MODEL	PIPE SIZE P	E	X	Y	Z	WT.
IS42 - 2	2	6	28	22	3	20
IS42 - 2 1/2	2 1/2	8	33	27	3	30
IS42 - 3	3	8	39	33	3	40
IS42 - 3 1/2	3 1/2	10	40	34	3	50
IS42 - 4	4	10	46	40	3	65
IS42 - 5	5	12	58	52	3	90
IS42 - 6	6	14	65	59	3	135
IS42 - 8	8	18	79	71	4	225
IS42 - 10	10	22	92	84	4	450
IS42 - 12	12	26	111	103	4	700

### Std. fittings

- up to 3 1/2" size - Male thread nipples
- 4" & 5" sizes - optional - male thread nipples or flanges
- 6" & above - 125 lbs. ANSI flange drilling

- Dimensions and weights are approximate and may change slightly with production models.
- Dimension in inches.
- Weight in lbs.

**We specialize in custom designs and also provide various nozzle orientations to suit your specific requirements.**

MODEL	PIPE SIZE P	E	X	Y	Z	G	F		WT.
							MIN.	MAX.	
IS42S - 2	2	6	25	22	3	8	6	8	20
IS42S - 2 1/2	2 1/2	8	30	27	3	9	6	9	30
IS42S - 3	3	8	36	33	3	10	7	11	40
IS42S - 4	4	10	43	40	3	12	9	14	65
IS42S - 5	5	12	55	52	3	14	11	15	90
IS42S - 6	6	14	62	59	3	15	12	19	135
IS42S - 8	8	18	75	71	4	21	12	21	225
IS42S - 10	10	22	88	84	4	28	14	26	450
IS42S - 12	12	26	107	103	4	33	16	30	700

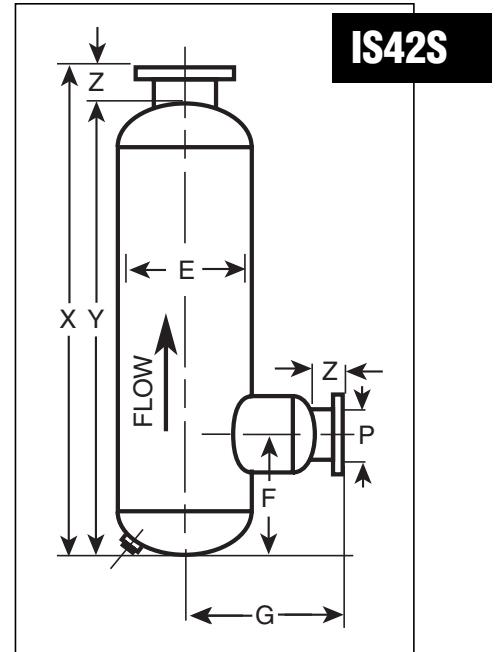

# SPECIFICATIONS

## IS43 Series Combination Chamber Absorption Type Intake Silencers

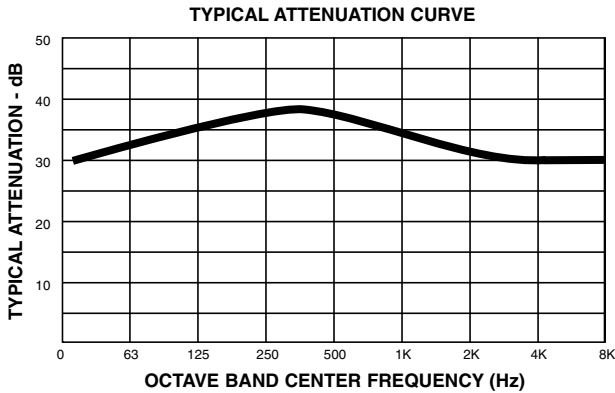

The IS43 Series Intake silencers are recommended for achieving **maximum silencing** for blowers operating **above transition speed** where noise level criteria are stringent. The design consists of a multi-chamber, multi-tube arrangement incorporating high frequency absorption packing material which effectively treats the destructive pulsations and excessive high frequency noise by converting noise energy into heat. The standard construction is heavy duty all welded carbon steel sheet and plates. The units 6" and above are provided with flanged connections drilled to 125 lbs. ANSI specifications. The external surfaces are rust inhibitive primer coated. Custom designs available to suit specific nozzle orientations. The optional features include inspection openings, mounting brackets, couplings for relief valve installations, special material, special paint or ASME code construction.

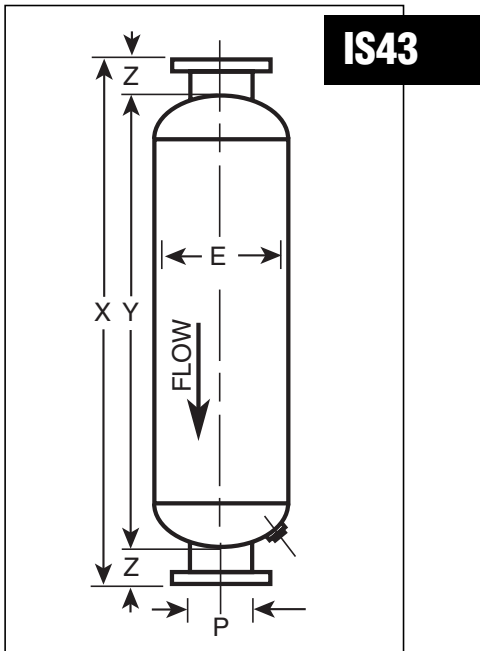

MODEL	PIPE SIZE P	E	X	Y	Z	WT.
IS43 - 2	2	8	33	27	3	30
IS43 - 2 1/2	2 1/2	10	34	28	3	45
IS43 - 3	3	10	51	45	3	60
IS43 - 4	4	14	53	47	3	105
IS43 - 5	5	16	65	59	3	165
IS43 - 6	6	18	72	66	3	205
IS43 - 8	8	22	68	60	4	320
IS43 - 10	10	26	81	73	4	470
IS43 - 12	12	30	100	92	4	750
IS43 - 14	14	30	111	103	4	860
IS43 - 16	16	36	120	112	4	1200
IS43 - 18	18	42	127	119	4	1600
IS43 - 20	20	42	140	130	5	2000
IS43 - 22	22	48	158	148	5	2700
IS43 - 24	24	54	167	157	5	3300

### Std. fittings

- up to 3 1/2" size - Male thread nipples
- 4" & 5" sizes - optional - male thread nipples or flanges
- 6" & above - 125 lbs. ANSI flange drilling

- Dimensions and weights are approximate and may change slightly with production models.
- Dimension in inches.
- Weight in lbs.

**We specialize in custom designs and also provide various nozzle orientations to suit your specific requirements.**



MODEL	PIPE SIZE P	E	X	Y	Z	G	F		WT.
							MIN.	MAX.	
IS43S - 2	2	8	30	27	3	9	6	9	30
IS43S - 2 1/2	2 1/2	10	31	28	3	10	7	10	45
IS43S - 3	3	10	48	45	3	11	7	16	60
IS43S - 4	4	14	50	47	3	14	8	18	105
IS43S - 5	5	16	62	59	3	15	9	21	165
IS43S - 6	6	18	69	66	3	17	10	24	205
IS43S - 8	8	22	64	60	4	18	12	26	320
IS43S - 10	10	26	77	73	4	21	14	33	470
IS43S - 12	12	30	96	92	4	25	16	37	750
IS43S - 14	14	30	107	103	4	31	17	39	860
IS43S - 16	16	36	116	112	4	33	19	43	1200
IS43S - 18	18	42	123	119	4	37	21	45	1600
IS43S - 20	20	42	135	130	5	41	22	46	2000
IS43S - 22	22	48	153	148	5	45	24	47	2700
IS43S - 24	24	54	162	157	5	49	26	53	3300

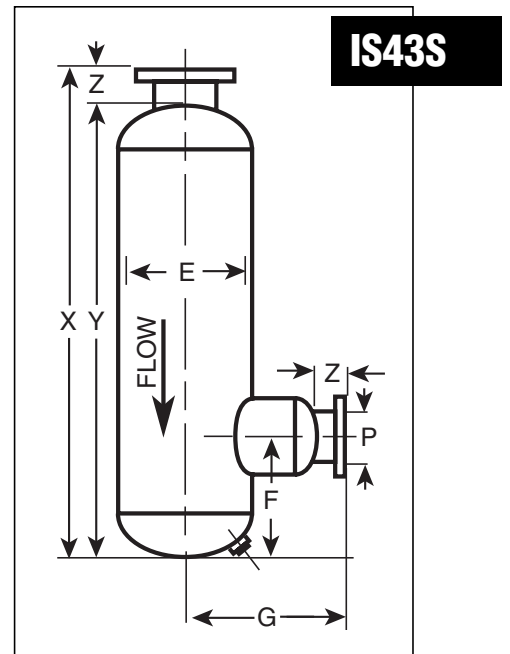

MODEL	PIPE SIZE P	E	X	Y	Z	G	K	F		WT.
								MIN.	MAX.	
IS43TS - 4	4	14	50	47	3	16	3 1/2	31	38	105
IS43TS - 5	5	16	62	59	3	18	4	41	50	165
IS43TS - 6	6	18	69	66	3	22	4 1/2	42	55	205
IS43TS - 8	8	22	64	60	4	25	5 1/2	41	49	320
IS43TS - 10	10	26	77	73	4	27	6	52	60	430
IS43TS - 12	12	30	96	92	4	34	7	55	65	700
IS43TS - 14	14	36	96	92	4	40	6	65	76	860
IS43TS - 16	16	36	116	112	4	43	9	73	90	1200
IS43TS - 18	18	42	123	119	4	50	10	84	99	1600
IS43TS - 20	20	42	135	130	5	56	9	85	110	2000
IS43TS - 22	22	48	153	148	5	58	11	100	120	2700
IS43TS - 24	24	54	162	157	5	63	13	103	130	3300

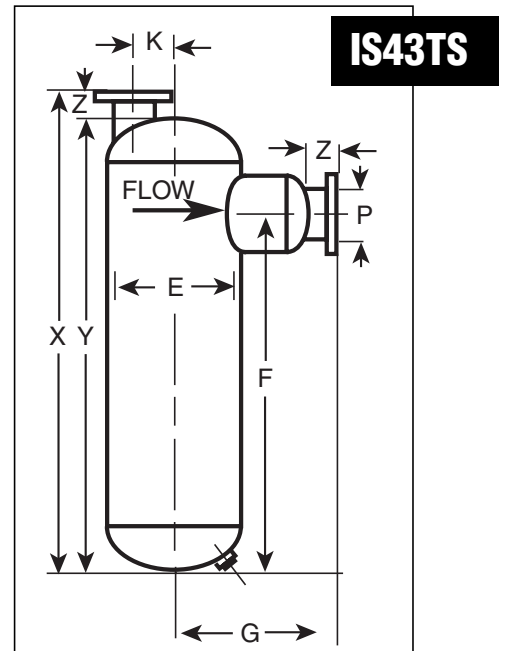

## **OTHER PRODUCTS AVAILABLE:**

- **ROTARY POSITIVE BLOWER INTAKE AND DISCHARGE SILENCERS**  
reference catalogue 1
- **BASE SILENCERS FOR ROTARY POSITIVE BLOWERS**  
reference catalogue 2
- **COMBINATION SILENCERS FOR ROTARY POSITIVE BLOWERS**  
reference catalogue 3
- **FAN SILENCERS**  
reference catalogue 4
- **CENTRIFUGAL COMPRESSOR SILENCERS**  
reference catalogue 5
- **VENT SILENCERS**  
reference catalogue 6
- **ENGINE SILENCERS**  
reference catalogue 7
- **NOISE ENCLOSURES**  
reference catalogue 8

**YOUR ONE STOP CENTER FOR  
ALL INDUSTRIAL SILENCING  
NEEDS.**



**E.I. Williams  
STEEL DIVISION  
BUILDING SOUND SOLUTIONS**

PLANT: 264 FAIRALL STREET, AJAX, ONTARIO L1S 1R6 CANADA  
TEL (905) 428 0950 FAX (905) 428 8343